

BLACK DIAMOND



OWNER'S MANUAL

MODEL: MP6000



N Please read all warnings and instructions carefully before operating this unit.

TABLE OF CONTENTS

BEFORE USE

Safety Precautions	01
Important Safety Instructions	02
Notice	03
Playable Discs	04
Accessories	04

CONTROL and CONNECTION

Front Panel and VFD	05
Basic connection	06
Remote control	08

BASIC PLAYBACK

Preparations	09
Basic Playback	09
Pause/Step Playback	09
Stop Playback	09
Previous and Next	09
Fast forward and Fast reverse	09
SLOW	09

Advanced Playback

OSD	10
V.MODE	10
PROGRAM	10
SEARCH	10

REPEAT	10
A-B REPEAT	10
ZOOM	10
ANGLE	10
INTRO	10
SUBTITLE	10
DSP	10
CLEAR	10
AUDIO	10
EQU	11
PAL/NTSC	11
MENU	11
TITLE	11
VOLUME and MUTE	11

SPECIAL FUNCTION

JPEG Disc Playback	11
MP3 Playback	11
Progressive scan	11
Kodak Picture CD Function	12
Karaoke	12

REFERENCE

System Setup	13
Trouble Shooting	18
DVD Characteristics	19
Special Function of DVD	20
Function Supported by DVD Discs	20
Specification	21



The lightning flash with arrowhead symbol, within an equilateral triangle, is intended to alert the user to the presence of uninsulated "dangerous voltage" within the product's enclosure that may be of sufficient magnitude to constitute a risk of electric shock to persons.



The exclamation point within an equilateral triangle is intended to alert the user to the presence of important operating and maintenance (servicing) instructions in the literature accompanying the appliance.



The symbol for CLASS II (Double Insulation).

WARNING: TO REDUCE THE RISK OF FIRE OR ELECTRIC SHOCK, DO NOT EXPOSE THIS APPLIANCE TO RAIN OR MOISTURE, DANGEROUS HIGH VOLTAGES ARE PRESENT INSIDE THE ENCLOSURE. DO NOT OPEN THE CABINET, REFER SERVICING TO QUALIFIED PERSONNEL ONLY.

CAUTION: When replace the direct plug in power supply or a separable, cord-connected power supply, the replacement must be exact duplicate, or one recommended by the manufacturer.

TO PREVENT ELECTRIC SHOCK, MATCH WIDE BLADE OF PLUG TO WIDE SLOT, FULLY INSERT.

This Digital Video Disc player employs a laser System.

Use of controls, adjustments or the performance of procedures other than those specified may result herein hazardous radiation exposure. To prevent direct exposure to laser beam, do not try to open the enclosure. Visible laser radiation when open and interlocks defeated.

DO NOT STARE INTO BEAM.



This product incorporates copyright protection technology that is protected by method claims of certain U. S. Patents and other intellectual property rights owned by Macrovision Corporation and other rights owners. Use of this copyright protection technology must be authorized by Macrovision Corporation, and is intended for home and other limited viewing uses only unless otherwise authorized by Macrovision Corporation. Reverse engineering or disassembly is prohibited.

Consumers should note that not all high definition television sets are fully compatible with this product and may cause artifacts to be displayed in the picture.

In case of 525 or 625 progressive scan picture problems, it is recommended that he used switch the connection to the "standard definition" output. If there are questions regarding your TV set compatibility with this model 525p and 625p DVD player, please contact our customer service centre.



Manufactured under license from Dolby Laboratories. "Dolby" and the double-D symbol are trademarks of Dolby Laboratories. Confidential unpublished works. Copyright 1992-1997 Dolby Laboratories. All rights reserved.



"DTS" and "DTS Digital Out" are trademarks of Digital Theater Systems, Inc.

CAUTION: PLEASE READ AND OBSERVE ALL WARNINGS AND INSTRUCTIONS GIVEN IN THIS MANUAL AND THOSE MARKED ON THE UNIT. RETAIN THIS BOOKLET FOR FUTURE REFERENCE.

This set has been designed and manufactured to assure personal safety. Improper use can result in electric shock or fire hazard. The safeguards incorporated in this unit will protect you if you observe the following procedures for installation, use and servicing. This unit is fully transistorized and does not contain any parts that can be repaired by the user.

DO NOT REMOVE THE CABINET COVER OR YOU MAY BE EXPOSED TO DANGEROUS VOLTAGE. REFER SERVICING TO QUALIFIED SERVICE PERSONNEL ONLY.

1.Read these manuals

After unpacking this product, read the manual carefully. Follow all the operating and other instructions.

2.Ventilation

Slots and openings in the cabinet are provided for ventilation and to ensure operation of the product. These protect it from overheating. These openings must not be blocked or covered. The openings should never be blocked by placing the product on a Bed, sofa, rug or other similar surface.

3.Heat

The product should be situated away from heat sources such as radiators, heat registers, stoves, or other products (including amplifiers) that produce heat.

4.Water and Moisture

Do not use this product near water for example, near a bathtub, wash bowl, kitchen sink, or laundry tub, in a wet basement or near a swimming pool.

5.Cleaning

Unplug this product from the wall outlet before cleaning. Do not use liquid cleaners or aerosol cleaners. Use a dry cloth for cleaning.

6.Power-cord protection

Power-supply cords should be routed so that they are not likely to be walked on or pinched by items placed upon or against them. Paying particular attention to cords at plugs, convenience receptacles, and the point where they exit from the product.

7.Lightning

For added protection for this product during storm, or when it is left unattended and unused for long periods of time, unplug it from the wall outlet. This will prevent damage to the product due to lightning and power-line surges.

8.Object and Liquid entry

Never push objects of any kind into this product through openings as they may touch dangerous voltage points or short-out parts that could result in a fire or electric shock. Never spill liquid of any kind on the product.

9.Attachments

Do not use attachments not recommended by the product manufacturer as they may cause hazards.

10.Accessories

Do not place this product on an unstable cart, stand, tripod, bracket, or table. The product may fall, causing serious injury to a child or adult, and serious damage to the product. Use only with a cart, stand, tripod, bracket, or

table recommended by the manufacturer, or sold with the product. Any mounting of the product should follow the manufacturer's instructions, and should use a mounting accessory recommended by the manufacturer. A product and cart combination should be moved with care.

Quick stops, excessive force, and uneven surfaces may cause the product and cart combination to overturn.



11.Disc tray

Keep your fingers well clear of the disc tray as it is closing. Neglecting to may cause serious personal injury and damage to the product.

12.Burden

Do not place a heavy object on or step on the product. The object may fall causing serious personal injury and serious damage to the product.

13.Damage Requiring Service

Unplug this product from the wall outlet and refer servicing to qualified service personnel under the following conditions:

- When the power-supply cord or plug is damaged.
- If liquid has been spilled, or objects have fallen into the product.
- If the product has been exposed to rain or water.
- If the product does not operate normally by following the operating instructions. Adjust only those controls that are covered by the operating instructions as an improper adjustment of other controls may result in damage and will often require extensive work by a qualified technician to restore the product to its normal operation.
- If the product has been dropped or damaged in any way.
- When the product exhibits a distinct change in performance - this indicates a need for service.

14. Servicing

Do not attempt to service this product yourself as opening or removing covers may expose you to dangerous voltage or other hazards. Refer all servicing to qualified service personnel.

15. Replacement Parts

When replacement parts are required, be sure the service technician has used replacement parts specified by the manufacturer or have the same characteristics as the original part. Unauthorized substitutions may result in fire, electric shock, or other hazards.

16.Safety Check

Upon completion of any service or repairs to this product, ask the service technician to perform safety checks to determine that the product is in proper operating condition.

NOTES ON HANDLING

- The top and rear panels of the unit may become warm after a long period of use. This is not a malfunction.
- When the unit is not use, be sure to remove the disc and turn off the power.
- If you do not use the unit for a long period, the unit may not function properly in the future. Turn on and use the unit occasionally.
- Do not place foreign objects on the tray.

LOCATION

Do not locate the unit in places such as:

- Near heating devices or in enclosed car.
- High temperature (40° C or higher) or high humidity (90% or higher).
- Dirty places.
- Avoid direct exposure to sunshine

DISTURBANCE

When you place this unit near a TV, radio or VCR, the playback picture may become poor and the sound may be distorted. In this case, place the unit away from the TV, radio or VCR.

NOTES ON MOISTURE CONDENSATION

The pickup may be condensed with water under the following situation.

- When you bring the unit directly from a cold place to a warm place.
- When you use the unit in a room where you just turned on the heater, or a place where the cold air from the air conditioner directly hits the unit.
- During the summer, when you use the unit in a hot and humid place just after you move the unit from an air conditioned room.
- The room is vaporous or damp.

If condensation exists, the unit will not operate properly. Remove the disc, connect the power cord of the unit to the wall outlet, turn on the unit, and leave it for two or three hours. After two or three hours, the unit will have warmed up and evaporated any moisture. Keep the unit connected to the wall outlet and moisture condensation will seldom occur.

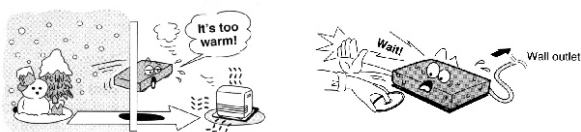

ON HANDLING DISCS

- Do not touch the playback side of the disc.
- Do not attach paper or tape to disc.



ON CLEANING DISCS

- Fingerprints and dust on the disc cause picture and sound deterioration. Wipe the disc from the centre outwards with a soft cloth. Always keep the disc clean.



- If you can not wipe off the dust with a soft cloth, wipe the disc lightly with a slightly moistened soft cloth and finish with a dry cloth.
- Do not use any type of solvent such as thinner, benzene, commercially available cleaners or antistatic spray for vinyl Lps. It may damage the disc.

ON STORING DISCS

- Do not store discs in a place subject to direct sunlight or near heat source.
- Do not store discs in place subject to moisture and dust such as a bathroom or near a humidifier.
- Store discs vertically in a case. Stacking or placing objects on discs outside of their cases may cause warping.

STRUCTURE OF DISC CONTENTS



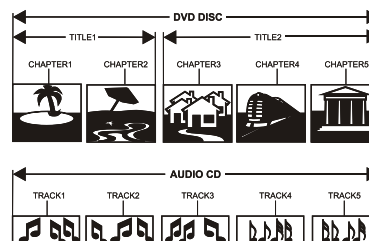







Normally, DVD discs are divided into titles, and the titles are sub-divided into chapters. Audio CD are divided into tracks.



Each title, chapter, or track is assigned a number, which is called title number, chapter number or track number respectively.

There may be discs that do not have these number.

The following discs can be playback:

DISCS	LABEL	CONTENTS	DIMENSION
DVD VIDEO		Audio +Video (moving picture)	12cm
			8cm
SUPER VCD (SVCD)		Audio +Video (moving picture)	12cm
			8cm
Video-CD (VCD)		Audio +Video (moving picture)	12cm
			8cm
AUDIO CD		Audio	12cm
			8cm
MP3	MP3	Audio	12cm
JPEG		Video(picture)	12cm
			8cm
KODAK CD		Video(picture)	12cm
			8cm
CD-R		Audio or Video	12cm
			8cm
CD-RW		Audio or Video	12cm
			8cm
HDCD		Audio	12cm
			8cm
WMA		Audio	12cm
			8cm
CD+G	CD+G	Audio	12cm
			8cm

- Discs other than those listed above can not be played.
- Non-standardized discs, even if they may be labeled as above can not be played.
- The performance of a recorded disc depends on the method and quality of disc-burning. In some cases, the disc may not play or play poorly.

ACCESSORIES

- Audio/Video cable 1
- Remote control 1
- Owner's manual 1
- Batteries..... 2
- Guarantee..... 1

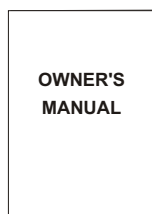

Owner's manual

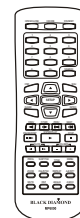

Remote control



Audio/Video cable



Two batteries

FRONT PANEL

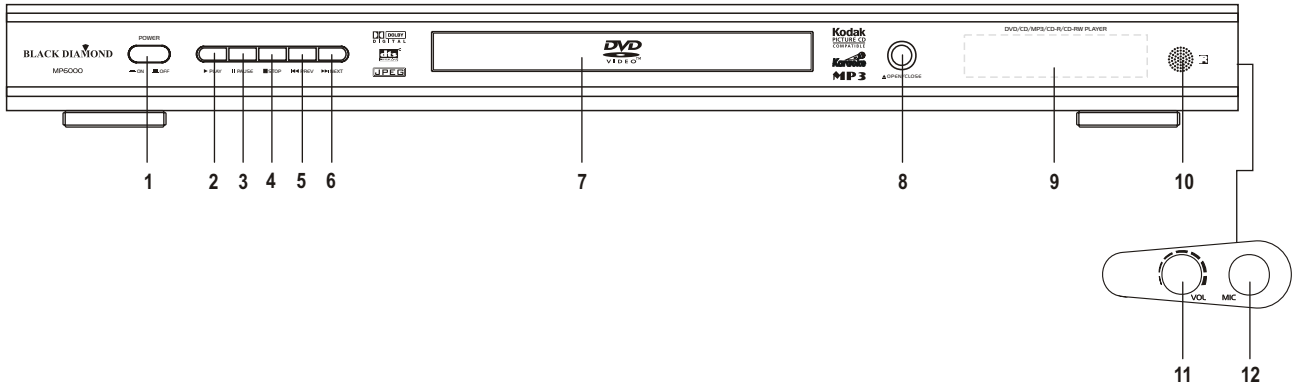

- | | |
|-----------------|---------------------------|
| 1. POWER SWITCH | 7. TRAY |
| 2. PLAY | 8. OPEN/CLOSE |
| 3. PAUSE | 9. VFD SCREEN |
| 4. STOP | 10. REMOTE CONTROL SENSOR |
| 5. PREVIOUS | 11. MIC VOLUME |
| 6. NEXT | 12. MIC SOCKETS |

VFD DISPLAY of DVD

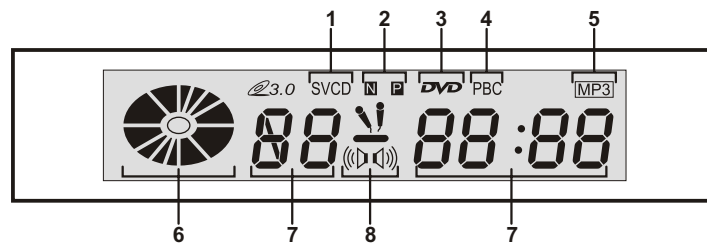

- | | |
|-------------------------------|---|
| 1. SVCD/VCD/CD disc indicator | 6. Rotate playback indicator |
| 2. NTSC/PAL indicator | 7. Multi-functional indicator
(indicates operating status or messages, etc.) |
| 3. DVD disc indicator | 8. Audio output indicator |
| 4. PBC on or off indicator | |
| 5. MP3 disc indicator | |

REAR PANEL OUTPUT

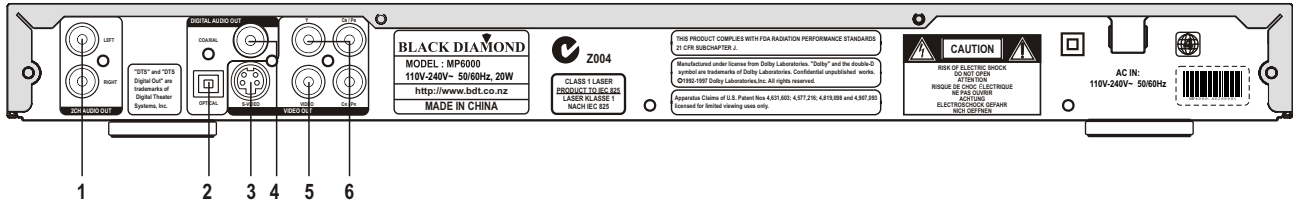

- | | |
|--|---|
| <ul style="list-style-type: none"> 1. 2 CHANNELS OUTPUT 2. OPTICAL FIBRE OUTPUT 3. S-VIDEO OUTPUT | <ul style="list-style-type: none"> 4. COAXIAL OUTPUT 5. VIDEO OUTPUT 6. Y, CB/PB, CR/PR OUTPUT |
|--|---|

BASIC CONNECTION

● Connecting to a TV with Audio/Video cable

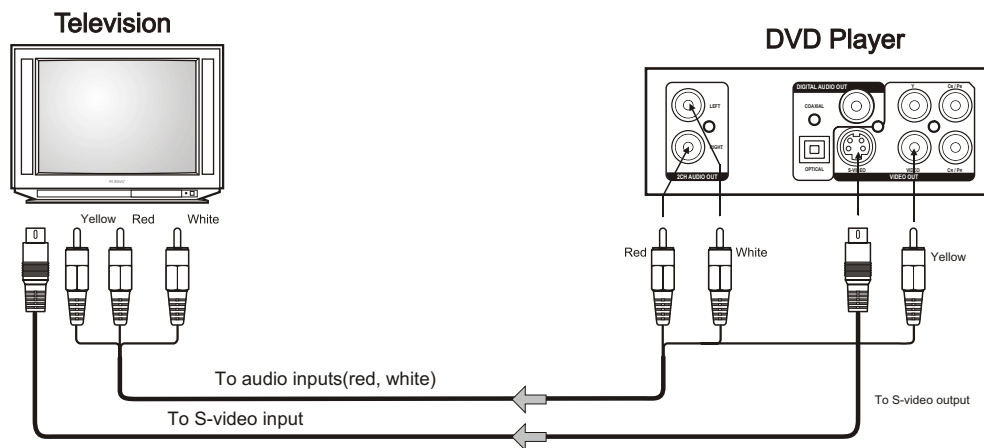

If the TV has an S-video input, connect the DVD player with an S-video cable.
When using an S-video cable, do not connect the yellow video cable.

● **Connecting to a audio system and TV equipped**

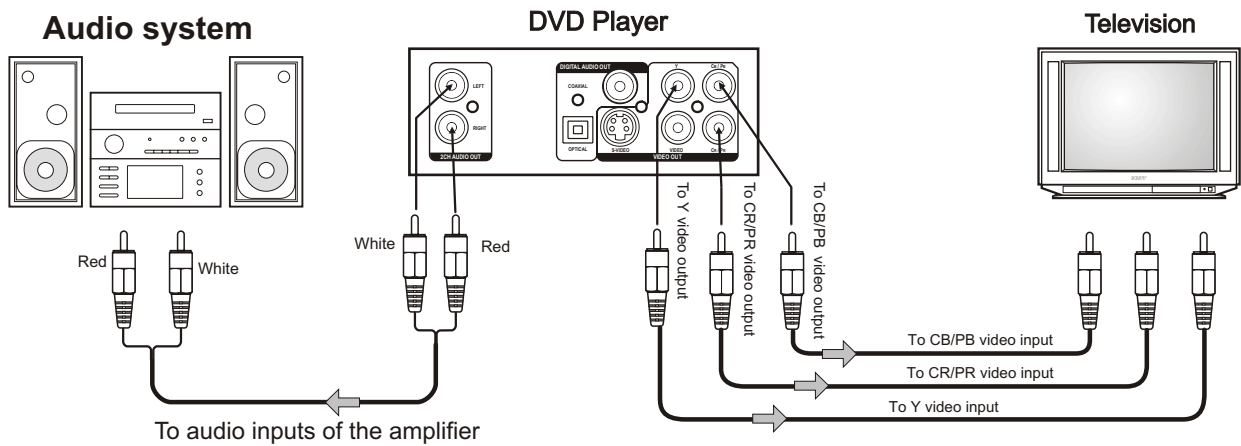

● **Connecting to an amplifier equipped with a digital audio input and TV**

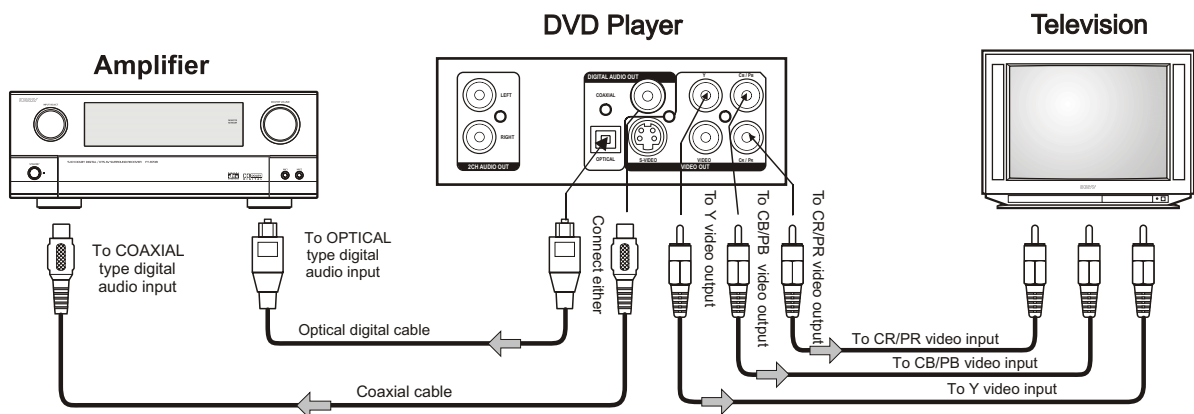

REMOTE CONTROL

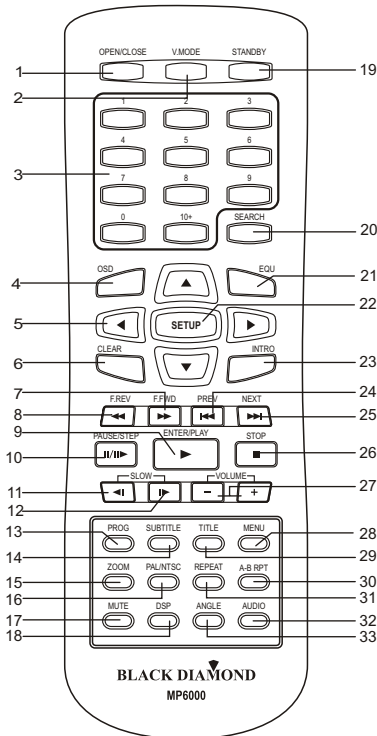

Function	See page	Function	See page
1. OPEN/CLOSE DISC TRAY	9	18. DSP	10
2. V.MODE	10	19. STANDBY	9
3. DIGITS AND 10+ BUTTONS	--	20. SEARCH	10
4. OSD	10	21. EQU	11
5. CURSOR	--	22. SETUP	13
6. CLEAR	10	23. INTRO	10
7. FAST FORWARD	9	24. PREVIOUS	9
8. FAST REVERSE	9	25. NEXT	9
9. ENTER/PLAY	9	26. STOP	9
10. PAUSE/STEP	9	27. VOLUME+/- (Volume Control)	11
11. SLOW BACKWARD	9	28. MENU	11
12. SLOW FORWARD	9	29. TITLE	11
13. PROGRAM	10	30. A-B REPEAT	10
14. SUBTITLE	10	31. REPEAT	10
15. ZOOM	10	32. AUDIO	10
16. PAL/NTSC	11	33. ANGLE	10
17. MUTE	11		

Loading Batteries

1. Open the cover.

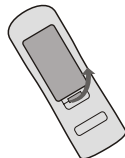

2. Insert batteries.

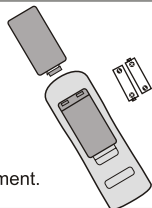

Make sure to match the + and - on the batteries to the marks inside the battery compartment.

3. Close the cover.

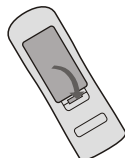

Notes on batteries

- Do not insert batteries into the remote control in the wrong direction.
- Do not charge, heat, open, or short-circuit the batteries. Do not throw batteries into a fire.
- Do not use different types of batteries together, or mix old and new batteries.
- If the remote control does not function correctly or if the operating range becomes reduced, replace all batteries with new ones.

Operating With The Remote Control

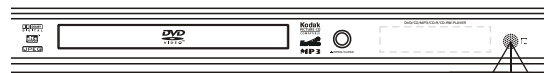

30° 30°
With about 7m (23 feet)

Distance: About 7m (23 feet) from the front of the remote sensor.
Angle: About 30° in each direction of the front of the remote sensor.

Do not expose the remote sensor of the DVD player to a strong light source such as direct sunlight or other illumination. If you do so, you may not be able to operate the DVD player via the remote control.

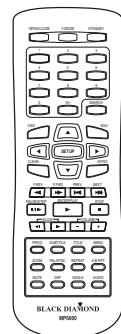

Notes on the remote control

- Direct the remote control at the remote sensor of the DVD player.
- Do not drop or give the remote control a shock.
- Do not leave the remote control near an extremely hot or humid place.
- Do not spill water or put anything wet on the remote control.
- Do not open the remote control.

Preparations

- When you want to view a disc, turn on the TV and select the video input connected to the unit.

Basic playback

1. Press POWER switch on the front panel, the DVD player turns on and the TV screen will display the start logo. If a disc is already in the tray, it will begin to play once.
2. Press OPEN/CLOSE ▲ to open the disc tray, place a disc on the disc tray.
 - There are two different disc sizes. Place the disc in the correct guide on the disc tray. If the disc is out of the guide, it may damage the disc and cause the unit to malfunction.
 - Do not place a disc which is unplayable in this unit.
3. Press OPEN/CLOSE to close the disc tray, the playback will automatically start.
 - Some disc maybe can not playback automatically, you can press ENTER/PLAY ► button to start playback.
4. Some discs may start playback with a menu. Use the cursor buttons on the remote controller to select menu options and press ENTER/PLAY to start, or press digits to select a menu option directly.

Pause/Step playback

1. Press PAUSE/STEP II/II► once to pause playback (still mode). The sound will be muted during still mode.
2. Press PAUSE/STEP II/II► repeatedly to step forward the next frames in the video.
3. Press ENTER/PLAY to resume normal playback.

Stop playback

1. Press STOP ■ button to go to stop mode, the TV screen will show the start logo. As some disc the unit can recall the location where stopped, such as DVDs and audio CDs.
2. Press ENTER/PLAY to playback to resume playback from the location where playback is stopped or from the beginning of the disc.
3. Press STOP twice to stop completely.

Previous and Next

During playing, press PREV I◀◀key to go back to the start of this chapter, then each press of this key will skip a chapter till the start of the disc. Each press of NEXT ►► key during playing will skip the current chapter and play the next one.

Fast forward and Fast reverse

1. Press F.FWD ►► to fast forward through the disc. Each time the F.FWD ►► button is pressed, the fast forward motion speed changes.
2. Press ENTER/PLAY to resume normal playback.
3. Press F.REV ◀◀ to fast reverse through the disc. Each time the F.REV ◀◀ button is pressed, the fast reverse motion speed changes.
4. Press ENTER/PLAY to resume normal playback.

SLOW

Press SLOW I► to play a disc in slow forward. Each time the SLOW I► button is pressed, the slow motion speed changes.

Press ENTER/PLAY to resume normal playback;

Press SLOW ◀I to play a disc in slow reverse. Each time the SLOW ◀I button is pressed, the slow reverse speed changes.

Press ENTER/PLAY to resume normal playback.

Note: This function is invalid for CD and MP3.

NOTES:

1. "⊙" may appear on the TV screen during operation. A "⊙" means that the operation is not permitted by the unit or the disc.
2. Under CPU control a screen saver may appear on the screen. Press any key to remove this. If you do not want to use this function, set SCREEN SAVER to OFF - see page 14.

IMPORTANT NOTE:

THE FOLLOWING FUNCTION DESCRIPTIONS ARE FOR DVDS, OPERATION AND DISPLAY ON SCREEN MAY BE DIFFERENT FOR OTHER FORMAT DISCS.

OSD (On Screen Display)

Pressing this button will cycle among "title elapsed", "title remain", "chapter elapsed", "chapter remain" and "display off".

V.MODE

This button can set VIDEO output to "CVBS", "YUV" interlaced or "YUV" progressive scan.

PROGRAM

When playing discs, press this button to enter program mode. Press digits to input the program number that you want, and when finished, move the cursor to select the "START" to start program playback. If you want to cancel this function, press "STOP", then press "ENTER/PLAY". This allows you to select and play only those chapters you want.

SEARCH

Press this button one time, the screen will display search menu, the second will cancel. In search menu, you can use UP/DOWN cursor button to select item what you wanted, Then press ENTER/PLAY button to confirm.

REPEAT

Press REPEAT and Chapter repeat will be displayed on screen, the second press will display Title repeat, the third press will display All repeat, the fourth press will cancel repeating.

A-B REPEAT

Press A-B RPT to begin start-point, press again to set an end point and complete setting. The selected section A-B will be repeated. The third press will cancel this function.

ZOOM

Press this button to enlarge or reduce the picture size. Each time the button is pressed, the magnification level will change.

ANGLE

For discs with this feature, press this key to view action from different angles.

INTRO

Press this button the screen display

Select Digest Type:

Title Digest

Chapter Digest

Title Interval

Chapter Interval

Select an item, press ENTER/PLAY and some thumbnail items will display. Move the cursor or input digits directly to select chapter you want, then press ENTER/PLAY. The disc will playback from where you select.

SUBTITLE

Press this button and the screen will display "SUBTITLE 01/XX XXXXX", "01" indicates the ordinal number of this language; "XX" indicates total number of languages; "XXXXXX" indicates the language of country. (the number of languages depends on disc).

DSP

Press this button, the Audio output will set to simulate various kinds of music effect like "ROCK", "POP", "LIVE", "DANCE", "TECHNO", "CLASSIC", "SOFT", "OFF".

CLEAR

This button can cancel incorrect information you input.

AUDIO

Press this button on remote control to change the mode of audio.

For example: Audio 1/2: MPEG 2 CH English
Audio 2/2: AC 3 5.1 CH English

EQU

Press " EQU " once, the screen will display EQU mode one; Press "EQU" second time to display EQU mode two. Press " EQU " third time will cancel this function.

PAL/NTSC

Press the key will switch among NTSC, PAL and Multi.

MENU

Press this button to display root menu, select item according to your preference. (This key is valid to DVDs possessing multi-layer menu.)

TITLE

On some DVD discs, pressing this button will display the title menu. You can press digits or cursor buttons to select the chapters preferred.

VOLUME and MUTE

Press " + " at the right of VOLUME to increase volume, " - " to decrease to volume. The first press MUTE will display Mute (no audio), the second press will return to normal.

JPEG DISC PLAYBACK

When playing JPEG disc, a navigation menu will be displayed automatically if the disc is loaded in succession. In the menu, use UP or DOWN in the cursor to select a file, then press "ENTER/PLAY", the file will be play with a slide-show. Press PREV or NEXT to select the previous or the next picture. Press PAUSE to pause the current picture for enjoying, when press ENTER/PLAY, it will return to normal playing. Press ZOOM to start zoom function. When ZOOM is on, press PREV or NEXT to switch among pictures; press F.REV and F.FWD to select different enlargement ratio, When ZOOM is off, press CURSOR key can move the enlargement picture. The picture can be rotated, inverted or mirrored as noted under Kodak playback.

IMPORTANT NOTE: High resolution pictures may have more flicker than lower resolution pictures.

MP3 PLAYBACK

When playing MP3 disc, a navigation menu will be displayed automatically if the disc is loaded in succession. In the menu, use UP or DOWN cursor buttons to choose folder, then press " ENTER/PLAY " button to confirm. In the folder, use UP or DOWN buttons to select the file, then press "ENTER/PLAY" to play this file. In this page, use LEFT cursor button to return to the previous menu, press PREV or NEXT to go to the previous or next page.

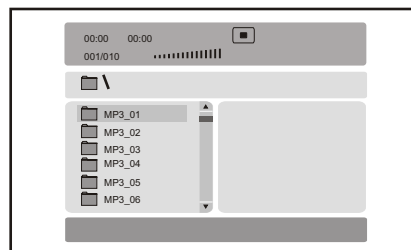

PROGRESSIVE SCAN

To use this feature a TV/display with progressive scan feature is required. Progressive scan (480P) is a method of creating a high-density video signal that doubles the scan lines of a conventional interlaced signal (480I) to create a noticeably sharp picture. Progressive scan requires only one 1/60th of a second pass as it scans all 525 horizontal lines at once (480 displayed), thus doubling the scan lines of interlaced signals for higher playback density. As a result, progressive scan offers high picture resolution and eliminates bothersome motion affects such as jagged edges on moving objects that are typical of a converted interlaced signal. The heart of Progressive Scan's advancement in picture quality is a high-density one-chip LSI (large-scale Integrated circuit) that performs the critical progressive signal processing tasks with high precision. The progressive-scan DVD-Video player recognizes the differences between film and video source material and adjusts its processing accordingly. The natural quality of film is preserved, while special filtering and intelligent edge enhancement produce video source images with natural motion and minimized flicker.

Kodak Picture CD Playback

Playback (Normal)

When a Kodak Picture CD is inserted on the unit, an automatic slide show is launched. Each picture in the Kodak Picture CD will be displayed consecutively in a slide-show fashion and will be scaled to fit in the whole TV screen. some slide-show transition modes are provided, use "PROG" key to select. Customer can set transition effects for each picture.

To display an image indefinitely, press the "PAUSE" key. To view the next or previous picture, press "NEXT" or "PREV" key. To resume the slideshow, press the "ENTER/PLAY" key.

Image Rotation

There are four modes to rotate a picture: "Invert", "Mirror", "Left", and "Right". These operations are allowed only when a picture is being displayed normally and will be cancelled automatically when a new picture is displayed. The arrow key is used to select the different rotation modes:

- | | | | |
|---------|-----------------|---------|--------------|
| Up ^ | - Invert/Normal | Left < | - Turn left |
| Down v | - Mirror/Normal | Right > | - Turn right |

Zoom

The "ZOOM" key is used to turn on or off this function. When this mode is on, any picture will be displayed at the last ratio selected by the user. A message on the screen will indicate the current zoom ratio. If zoom mode is on, "F.FWD" and "F.REV" key are used to control the ratio of zoom in/out. With ZOOM mode off, a picture is scaled to fit the whole TV screen.

Notes: During zoom function, slide-show transition and image rotation are disabled. To cancel the zoom function press the "ZOOM" key again to resume the slide-show.

Digest

The "STOP" key is used to display thumbnail size pictures. After it is enabled, some scaled-down thumbnail pictures will be displayed on the screen. The "NEXT" and "PREV" keys can be used to display the next/prev pictures in the Kodak Picture CD.

You can select any of the displayed thumbnails by using the Arrow Keys and pressing the "ENTER/PLAY" key. The thumbnail will be enlarged to fit the TV screen and the slide show will start. If you desire to display an image indefinitely, press the "PAUSE" key. To view the next or previous picture press "NEXT" or "PREV" key. To resume the slide show press the "ENTER/PLAY" key.

IMPORTANT NOTE: Quality of pictures displayed on the screen is highly dependent on the viewing device.

KARAOKE

- Follow steps below to enjoy KARAOKE
 1. Press MIC volume button, then the button pop out and plug the microphone into MIC socket;
 2. Place the disc in tray, please start singing in playback;
 3. Turn MIC VOLUME to adjust microphone volume.



- If feedback occurs
 1. Move the microphone away from TV or speaker
 2. Turn down the Volume of TV or amplifier
 3. Turn down the Volume of microphone

- When you press **SETUP** key on the remote control, the setup menu will be displayed.
 - Within the setup menu, you can use UP, DOWN, LEFT and RIGHT buttons on the remote control to move the cursor, and then press the ENTER/PLAY button to make your selection. Press LEFT can return the previous menu.
 - To exit setup menu, press the SETUP button.

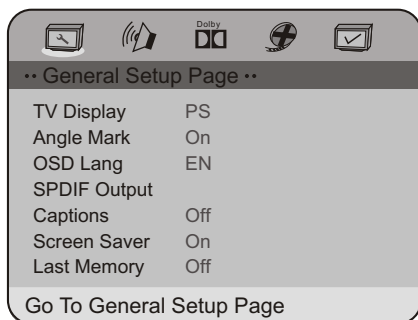

1. GENERAL SETUP PAGE

Setup TV screen format, video type and all DVD functions.

1.1 TV DISPLAY

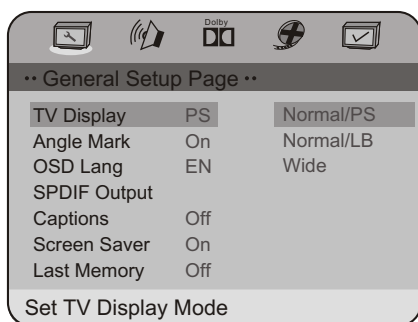

Users can select different display formats and TV screen type. There are various types of display on screen for different matches between Disc and TV (Please see page 20: Multi-image ratio mode)

Note:

- No matter which display format is selected, a picture recorded in standard 4:3 format always displays in the 4:3 aspect ratio.
- The display format of DVD titles may vary; please refer to the information that accompanies your specific DVD title.
- If the DVD title is recorded in 16:9 wide display format while the TV is a standard 4:3 screen, horizontal compression of the image will result.
- Some DVD titles may be recorded in special formats. In such cases, the DVD titles will always appear on the screen in their original format, regardless of which TV display format you select.

1.2 ANGLE MARK

ANGLE MARK: Users can select a particular camera angle when playing a DVD which offers multiple angles.

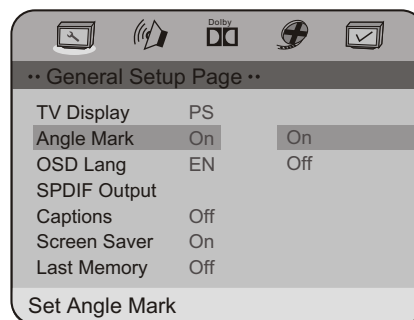

1.3 OSD LANGUAGE

On Screen Display (OSD) Language: Users can select the whole setup menu and on-screen display language.

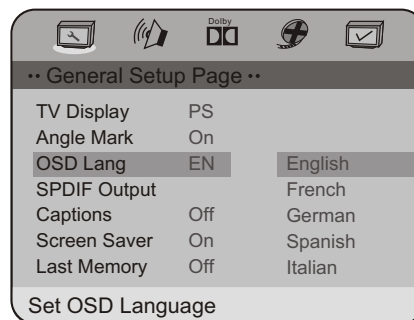

1.4 SPDIF OUTPUT

SPDIF OUTPUT MODE: Sets the audio outputs.

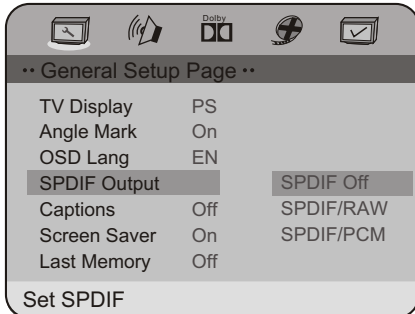

- This DVD player includes three kinds of audio output:
- SPDIF OFF:** An analog surround sound format is output through the back-panel connections for 2-CH audio out or 5.1 CH audio out.
 - SPDIF/RAW or SPDIF/PCM:** This surround sound format is output to a Dolby Digital / DTS decoder through the optical and coaxial connectors on the back-panel of the product.

1.5 CAPTIONS

CAPTIONS: For hearing-impaired people, the picture can be displayed with recorded explanatory captions.

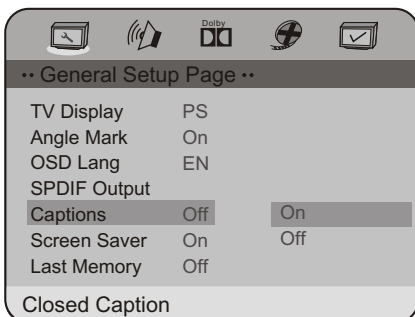

1.6 SCREEN SAVER

SCREEN SAVER: If the screen saver is set On, an animated picture will appear on the screen whenever the DVD player is idle for a certain time.

Note: Press any key to remove screen saver from screen.

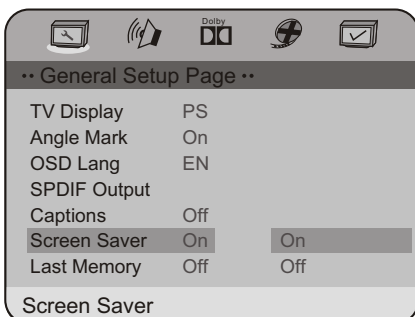

1.7 LAST MEMORY

LAST MEMORY: This function is convenient when you want to continue viewing a disc from the point where you were watching before. Unlike the resume function, the Last Memory function is effective even the disc is removed from the player.

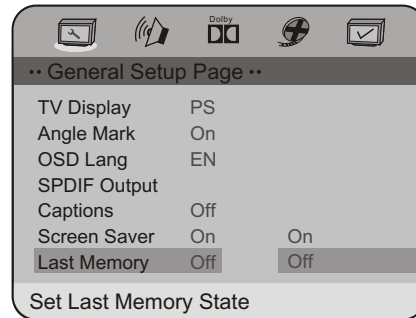

- When Last Memory is ON, each time when you open the tray to remove the disc or place the player into standby mode, the player will remember the point where you stopped and continue to play from the point.
- The function is effective while the player has power on. The Last Memory is held when in standby mode.

2. SPEAKER SETUP PAGE

2.1 SPEAKER SETUP

DOWNMIX MODE: sets front speakers to LT/RT, STEREO.

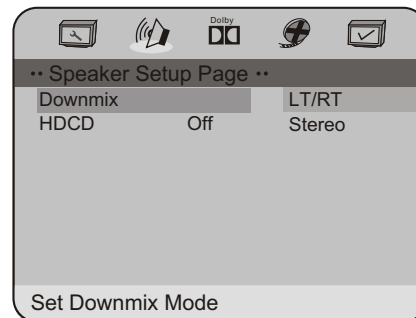

2.2 HDCD SETUP

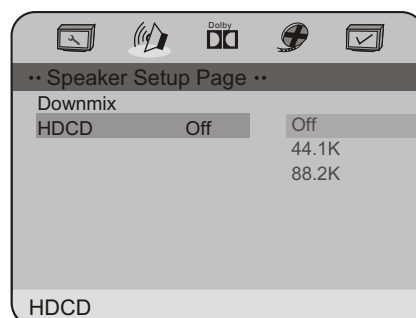

Please choose the sampling frequencies of digital filter, the higher the sampling frequencies are, the clearer the audio quality is. When default setting is Off, it will display "CD" when reading HDCD. For HDCD playback, please choose 44.1K or 88.2K.

3. DOLBY DIGITAL SETUP PAGE

3.1 DUAL MONO

DUAL MONO: If your amplifier / decoder has Dolby Digital output, you may select stereo, left mono, right mono, or mixed mono mode for your amplifier decoder.

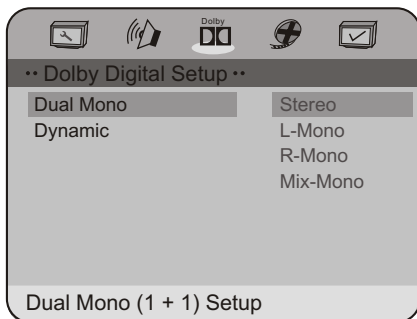

3.2 DYNAMIC

DYNAMIC: this function is generally used when playing high volume programs at night, in order not to disturb the neighbour. This setting can dynamically lower the volume and still keep the original tone quality. This is the range, measured in decibels(dB), between the loudest and the quietest sound registers in a soundtrack.

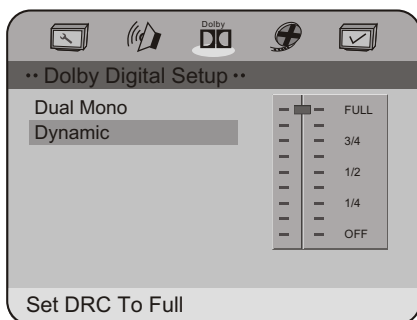

4. VIDEO SETUP PAGE

4.1 COMPONENT

COMPONENT: Sets the video output.

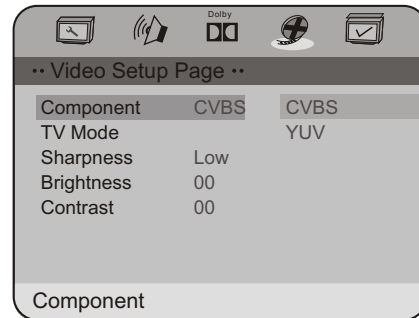

4.2 TV MODE SETUP

TV MODE: Set the scan mode to the same as your TV.

NOTE: Progressive Scan available in YUV mode only.

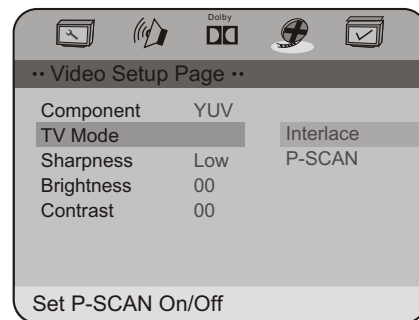

4.3 SHARPNESS

SHARPNESS: Sets the sharpness level of video output.

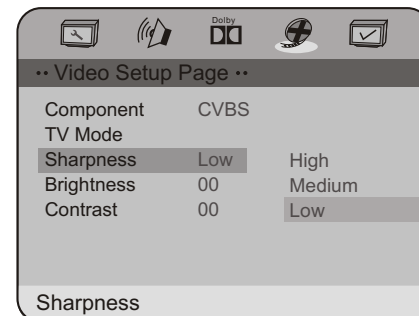

4.4 BRIGHTNESS

BRIGHTNESS: Sets the brightness level of video output.

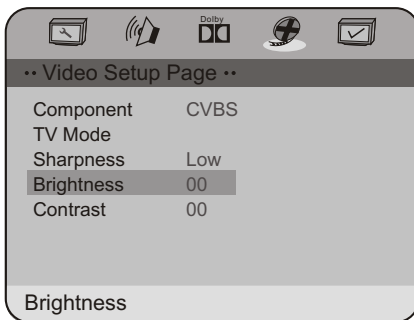

Press right button the TV will display below.

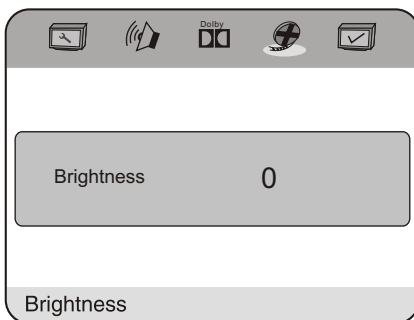

Press LEFT/RIGHT button to adjust, then press ENTER/PLAY button to confirm and return to menu.

4.5 CONTRAST

CONTRAST: Sets the contrast level of Video output.

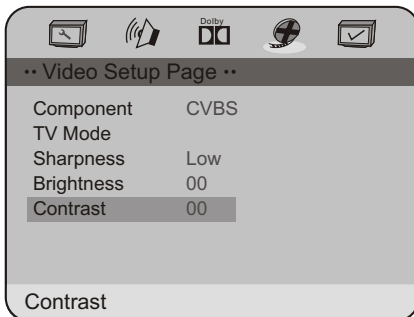

Press right button the TV will display below.

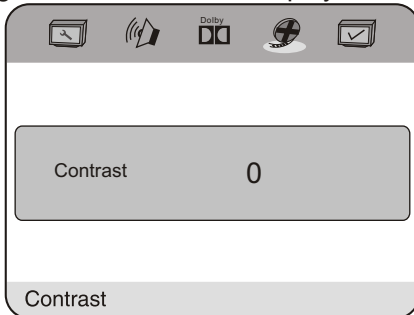

Press LEFT/RIGHT button to adjust, then press ENTER/PLAY button to confirm and return to menu.

5. PREFERENCE SETUP PAGE

The preference setup is active only when no disc is loaded. The settings remain set until changed at a later time.

5.1 TV TYPE

TV TYPE: This player supports different TV outputs, including MULTI(Auto), NTSC, and PAL systems.

- If your TV support only NTSC or PAL and you inadvertently select the wrong TV type, the TV screen will flicker and be black-and-white. In this case, you should press the SETUP button to set as following **Note**.

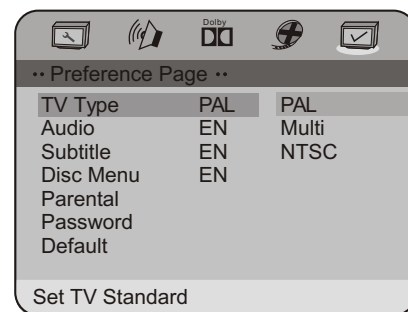

Note: How to Set the TV Type?

- You may switch the NTSC/PAL setting of the DVD player to match the video signal of your TV.
- The table below shows what kinds of disc are compatible with each setting (MULTI, PAL and NTSC)

Disc		Output Format		
Type	Format	Selected TV System Mode		
		NTSC	PAL	MULTI
DVD	NTSC	NTSC	PAL	NTSC
	PAL	-----	PAL	PAL

5.2 AUDIO

AUDIO: Sets the preferred audio language as the default when playing DVD. (If DVD supports that language)

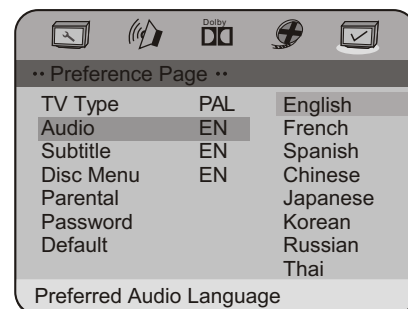

5.3 SUBTITLE

SUBTITLE: Sets the preferred subtitle language as the default when playing DVD.(If DVD supports that language)

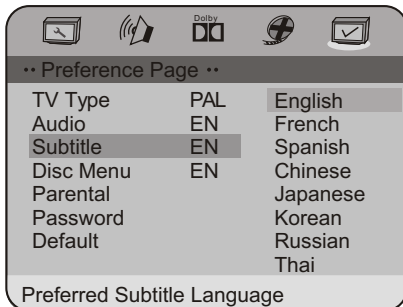

5.4 DISC MENU

DISC MENU: Sets the preferred menu language as the default when playing DVD.(If DVD supports that language)

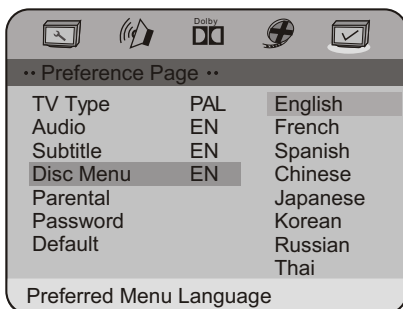

5.5 PARENTAL

PARENTAL: The parental control function works in conjunction with the different censorship classes assigned to DVDs. These classes help to control the types of DVDs that the family watches, There are up to 8 censorship classes for DVDs.

Note:
To change this setting, you must input your password.
(Initial password : 1369)

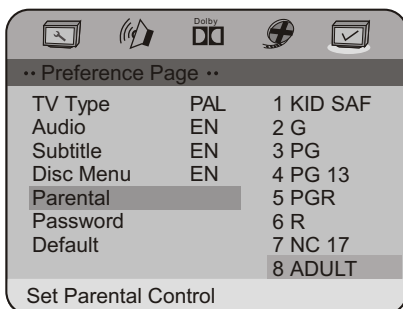

5.6 PASSWORD MODE

PASSWORD CHANGE: you can change the password, please type 4 numerals as new password.

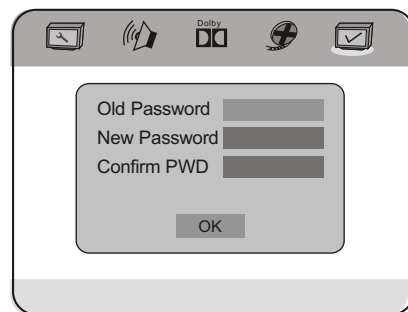
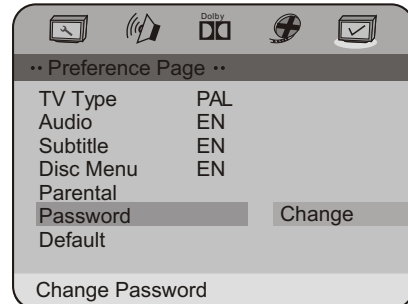

5.7 DEFAULT

DEFAULT: Resets to all the manufacturer's original settings for this DVD player Press ENTER to perform the reset.

Note: Use this only if all else fails as you will lose all your personal settings!

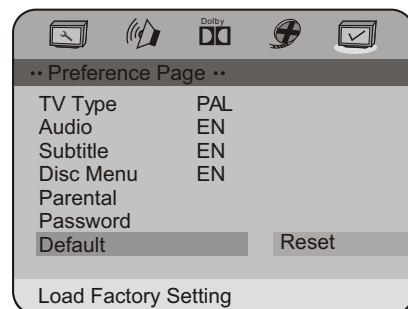

Please check the following guide for the possible cause and solution for a problem before contacting the nearest service center or dealer for repairs.

SYMPTOMS AND CORRECTIONS

SYMPTOMS	CORRECTIONS
No power	Check to make sure that the power cord is plugged in properly.
No picture	Make sure the connections between the player and the TV are OK.
	Make sure that the TV is in good working condition.
No sound	Make sure the connections between the player and other devices are OK.
	Make sure that the TV and AMP are in good working condition and setup properly.
Failed to Play	Check that the disc is properly inserted.
	Clean the disc.
Failed to respond to remote control	Remove obstacles between remote control and unit.
	Aim remote control at the sensor on the front panel
	Check batteries and replace them if necessary.
Picture Disturbance	Check the disc for dirt and scratches. Clean or replace disc.
	Shut down the unit, wait ten seconds, and restart the unit.
Failed to work with keys	Power surges or brown outs or other electrical phenomena. Shut down the unit, wait ten seconds, and restart the unit.
	Check V.MODE setting via remote.

DVD player is the ticket of your home theater. Every technical index of this machine is far more superior to any previous audio-visual equipment. This completely new digital technology has compressed the audio visual effect of cinema into 12cm diameter disc which is the same in dimension as the CD disc. Especially the Dolby digital output can provide prominent digital surround effect. It can also be compatible with the existing CD, CD-R and CD-RW (It can not be compatible with some CD-RW discs).

Compare DVD disc with other discs:

	DVD				LD	SVCD	VCD	CD
Encode method	Digital/MPEG II				Analog	Digital	Digital/MPEG I	Digital
Capacity	Single-side single-layer 4.7G	Double-side single-layer 8.5G	Single-side double-layer 9.4G	Double-side double-layer 17G	/	650MB	650MB	650MB
Playing Time	133 minutes	242 minutes	266 minutes	484 minutes	Single-side 60 minutes double-side 120 minutes	45 minutes	74 minutes	74 minutes
Disc diameter	12cm/8cm				30cm/20cm	12cm	12cm	12cm/8cm
Horizontal resolution	More than 500 lines				No more than 430 lines	No more than 350 lines	No more than 250 lines	/
Picture proportion	Multiple kinds				One kind	One kind	One kind	/
Subtitle	32 kinds				16 kinds at most	4 kinds	/	/
Language	8 kinds				4 kinds at most	4 kinds at most	2 kinds	2 kinds
Sound quality	48KHz, 96KHz/ 6, 20, 24bit				44.1KHz/ 16bit	44.1KHz/ 16bit	44.1KHz/ 16bit	44.1KHz/ 16bit

PARENTAL LOCK

This player lets you set the Parental Lock if the DVD has a parental lock level recorded on it. With Parental Lock capable discs, you can block access to material you feel is inappropriate for your children. Refer to the DVD disc jacket and the accompanying documentation to see if a particular disc contains a parental lock level.

MULTI-LANGUAGE SUPPORT

DVD allows up to 8 languages and 32 subtitles on a single disc.

MULTI-SCENARIO SUPPORT









There are different scenarios for the user to select in appreciating a program.

SETTING THE TV SCREEN SIZE

Multi-aspect ratio suit to different TV screen size.

MULTI-ANGLE SUPPORT

You can select a camera angle when viewing DVDs with the multi-angle option.

Picture format on Disc	TV Screen Size		
	4:3		16:9
	Pan Scan	Letter-box	Wide Screen
4:3 			
16:9 			

Function supported by DVD discs

There are many functions available on DVD discs and the functions vary per player and per manufacturer. These are the functions that this DVD player supports.



Regional code and signal system



Dolby digital surround sound



DTS output



Number of languages



Subtitle languages

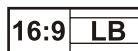

Picture proportion modes



Parent lock



Angles for viewing



Closed Caption

System and Outputs

VF Signal system	PAL/NTSC		
Frequence response	CD: 4Hz-20KHz(EIAJ) DVD: 4Hz-22KHz(48KHz)(Sample result) 4Hz-44KHZ(96KHz)(Sample result)		
Audio S/N ratio	> 90 dB		
Video/Picture	MPEG1 V2.0; MPEG2		
Audio	MPEG LAYER2 standard		
Audio output (analog audio)	Electric level output: 1.8V	resistance: 10K	
Audio output (digital audio)	Electric level output: 0.5Vp--p	resistance: 75	
Video output	Electric level output: 1Vp--p	resistance: 75	Unbalanced negative
S-Video output	Electric level output: brightness(Y)1Vp--p, Chrominance (C): 0.286Vp--p, resistance: 75		

General

Power	110V-240V~ 50/60Hz
Power consumption	< 20W
Product Dimensions	L: 430mm W: 270mm H: 46mm
Weight	2.8kg
Operating temperature	5°C to 35°C (41°F to 95°F)
Operating humidity	5% to 90%

Note: We reserve the right to modify the design without notice!

BLACK DIAMOND